

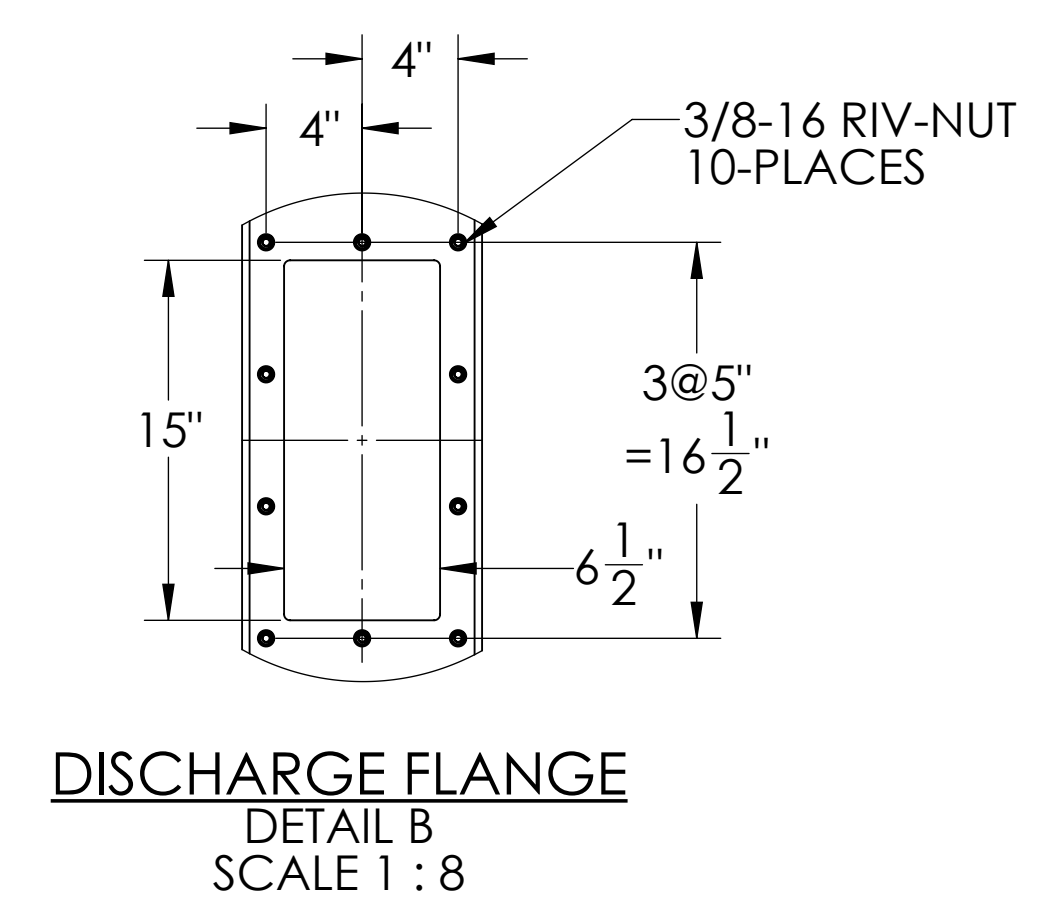

FOOT PRINT
SECTION A-A



DISCHARGE FLANGE
DETAIL B
SCALE 1 : 8

THIS DRAWING IS A CONFIDENTIAL DISCLOSURE AND IS LOANED TO RECALL AT ANY TIME WITH THE UNDERSTANDING THAT IT WILL NOT BE USED IN ANY WAY DETRIMENTAL TO THE INTERESTS OF IMPERIAL SYSTEMS.			
DESIGN DATA:	HOOD VOLUME: 725 CU.FT. AIR FLOW: 850 CFM	DRAWN BY TEB	DATE 11/13/20
PAINT COLOR: IMPERIAL FLAT BLACK		WEIGHT (lbs)	
FINISH: ALL SHARP EDGES TO BE ROUNDED TO A SMOOTH RADIUS. ALL BURRS, WELD SPATTER AND ALL OTHER SHARP PROJECTION TO BE GROUND SMOOTH.		 7320 W. MARKET ST. MERCER, PA 16137 T: 724-662-2801 F: 724-662-2803 www.isystemsweb.com	
UNLESS OTHERWISE SPECIFIED: 1. NO BURRS OR SHARP EDGES 2. MACHINED SURFACES 125 Ra, DRILLED HOLES 250 Ra			
TOLERANCES UNLESS OTHERWISE INDICATED .0 ± .020 FRACTIONS: ± 1/8 .00 ± .010 ANGULAR: ± 1° .000 ± .005		AIRPORT 10FT X 7FT X 9FT	
SCALE 1:24	DO NOT SCALE DRAWING	SHEET 1 OF 1	DRW. NO. AP100709

*OPTIONAL CRANE SLOTS, CURTAIN STRIPS & LIGHT FIXTURE AVAILABLE.