

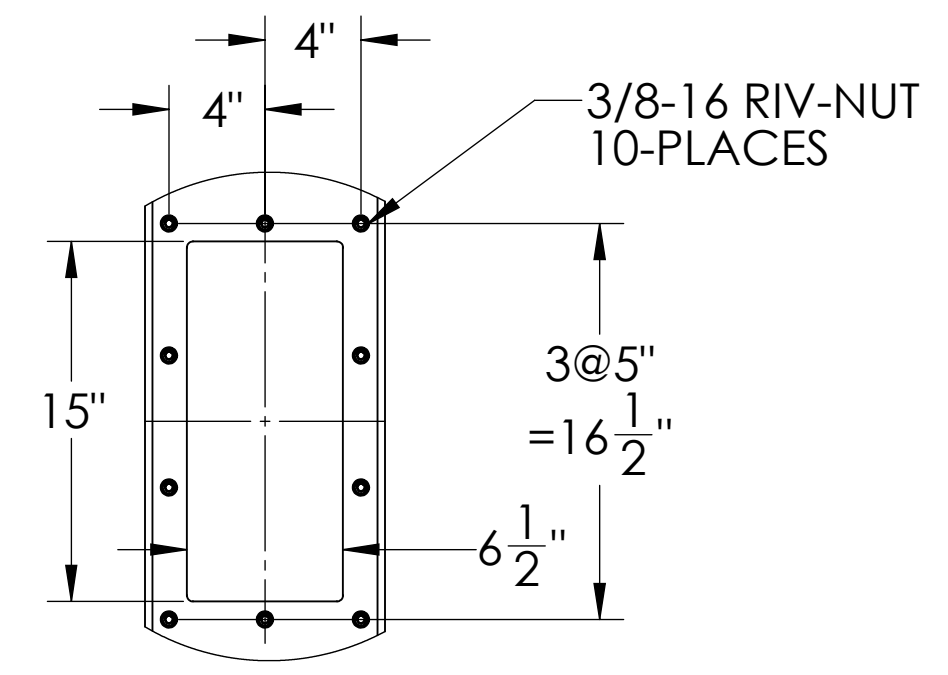

FOOT PRINT SECTION A-A



DISCHARGE FLANGE DETAIL B SCALE 1 : 8

THIS DRAWING IS A CONFIDENTIAL DISCLOSURE AND IS LOANED TO RECALL AT ANY TIME WITH THE UNDERSTANDING THAT IT WILL NOT BE USED IN ANY WAY DETRIMENTAL TO THE INTERESTS OF IMPERIAL SYSTEMS.

DESIGN DATA:	HOOD VOLUME: 700 CU.FT. AIR FLOW: 850 CFM	DRAWN BY	DHE	DATE	10/26/20	WEIGHT (lbs)	
PAINT COLOR:		IMPERIAL FLAT BLACK		 7320 W. MARKET ST. MERCER, PA 16137 T: 724-662-2801 F: 724-662-2803 www.isystemsweb.com		AIRPORT 8FT X 9FT X 8FT	
FINISH:		ALL SHARP EDGES TO BE ROUNDED TO A SMOOTH RADIUS. ALL BURRS, WELD SPATTER AND ALL OTHER SHARP PROJECTION TO BE GROUND SMOOTH.					
UNLESS OTHERWISE SPECIFIED:		1. NO BURRS OR SHARP EDGES 2. MACHINED SURFACES 125 Ra, DRILLED HOLES 250 Ra		TOLERANCES UNLESS OTHERWISE INDICATED			
		.0 ± .020 FRACTIONS: ± 1/8 .00 ± .010 ANGULAR: ± 1° .000 ± .005					
SCALE	1:24	DO NOT SCALE DRAWING		SHEET	1 OF 1	DRW. NO.	AP080908

*OPTIONAL CRANE SLOTS, CURTAIN STRIPS & LIGHT FIXTURE AVAILABLE.