

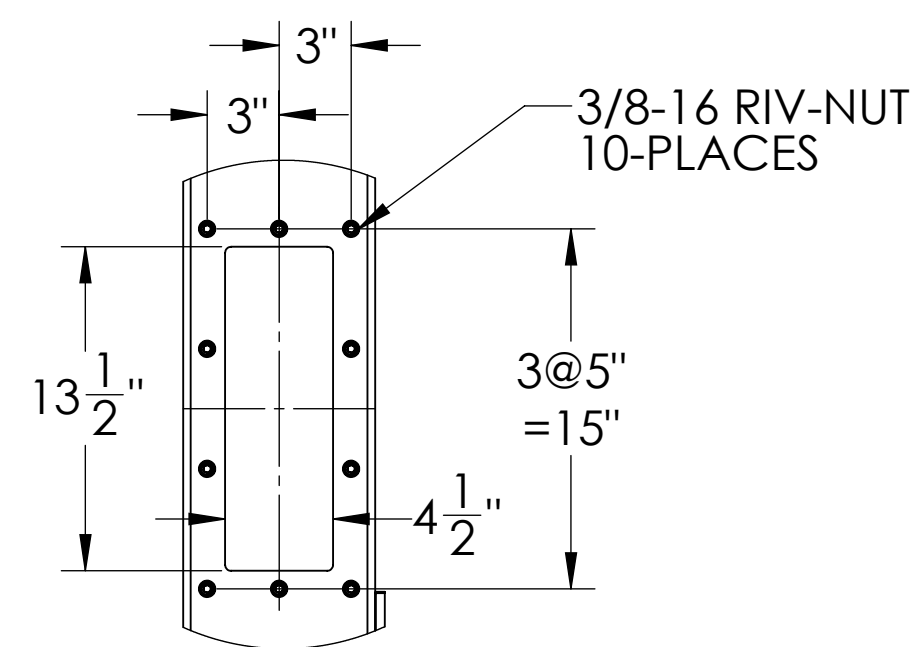

FOOT PRINT
SECTION A-A



DISCHARGE FLANGE
DETAIL B
SCALE 1 : 8

*OPTIONAL CRANE SLOTS, CURTAIN STRIPS & LIGHT FIXTURE AVAILABLE.

THIS DRAWING IS A CONFIDENTIAL DISCLOSURE AND IS LOANED TO RECALL AT ANY TIME WITH THE UNDERSTANDING THAT IT WILL NOT BE USED IN ANY WAY DETRIMENTAL TO THE INTERESTS OF IMPERIAL SYSTEMS.			
DESIGN DATA:	HOOD VOLUME: 200 CU.FT. AIR FLOW: 850 CFM	DRAWN BY DHE	DATE 10/26/20
PAINT COLOR: IMPERIAL FLAT BLACK		WEIGHT (lbs)	
FINISH: ALL SHARP EDGES TO BE ROUNDED TO A SMOOTH RADIUS. ALL BURRS, WELD SPATTER AND ALL OTHER SHARP PROJECTION TO BE GROUND SMOOTH.		 7320 W. MARKET ST. MERCER, PA 16137 T: 724-662-2801 F: 724-662-2803 www.isystemsweb.com	
UNLESS OTHERWISE SPECIFIED: 1. NO BURRS OR SHARP EDGES 2. MACHINED SURFACES 125 Ra, DRILLED HOLES 250 Ra		AIRPORT 4FT X 5FT X 8FT	
TOLERANCES UNLESS OTHERWISE INDICATED .0 ± .020 FRACTIONS: ± 1/8 .00 ± .010 ANGULAR: ± 1° .000 ± .005		SCALE 1:24	
DO NOT SCALE DRAWING		SHEET 1 OF 1	DRW. NO. AP040508